

Worship Seating Buyer's Guide

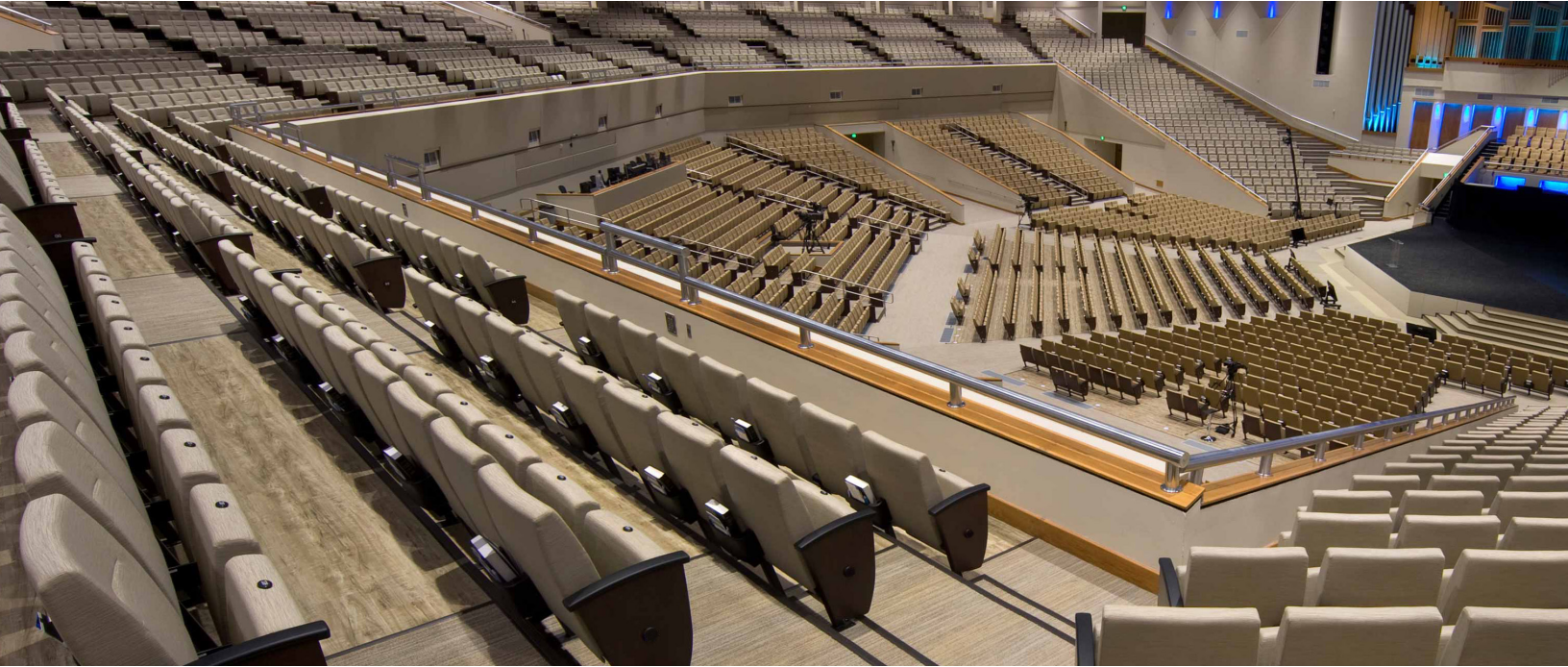



Integrity Furniture is pleased to present you with this copy of our “Worship Seating Buyer’s Guide.” Throughout the pages of this catalog, you will find commercially made worship seating products to meet any style of worship.

Since 2000, Integrity Furniture has offered churches three unique and different forms of seating. For churches that need flexibility, we offer stacking chairs from Comfortek and Bertolini. These companies produce comfortable seating that allows you to use your space during the week for things other than worship. These chairs can be configured in straight or curved rows and aisles can be created where and when you need them.

For more contemporary worship venues, Integrity Furniture can provide you fixed theater seating that offers a comfortable seating experience that includes wider seat widths than traditional stack chairs. We can show you how a theater seat can provide 20% more seating capacity than traditional pews using the same footprint.

For the more traditional worship spaces, we can connect you with several different pew manufacturers depending on your location in the United States and your budget. We can also provide the corresponding furniture of communion tables, pulpits, tithe boxes, and chancel furniture.

With over 200 manufacturers at our fingertips, we can assist you in furnishing the rest of your building as well. We give you a sneak peek of what we offer on pages 28-29 or you can visit our website at www.integrityfurniture.com.

We look forward to helping you design and experience a worship area that is welcoming and provides comfort and durability for years to come. We welcome the opportunity to work with you in regards to your worship seating needs. Please call us at 1-888-600-8639 to answer any of your questions or if you want to schedule a meeting with one of our sales representatives.

With Integrity,
Drew Coleman
President/Owner

TABLE OF CONTENTS



COMFORTEK 2-8
 Comfortek SS7701-HZ 3
 Comfortek SS7701-X 4
 Comfortek Options 5
 Comfortek SS661 6 & 7
 Comfortek 791G 8



BERTOLINI 9-13
 Bertolini Essentials 10
 Bertolini Millennia 11
 Bertolini Impressions 12
 Bertolini Options 13

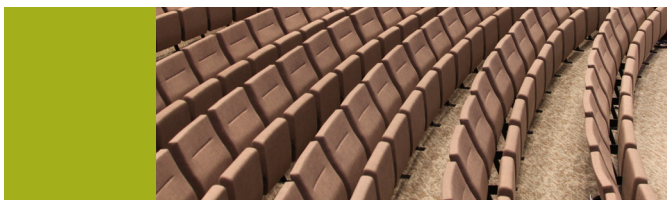

SERIESTHEATER SEATING 14-19
 Series Benefits 16
 Series Space Stewardship 17

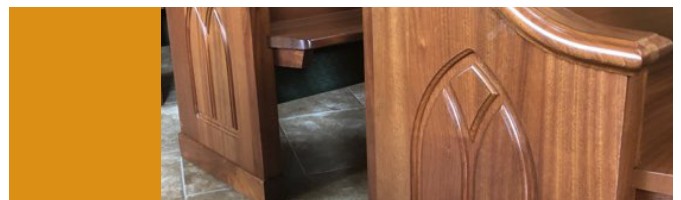

PEWS 20-23
 Pew Upholstery 22
 Pew Refinishing 23

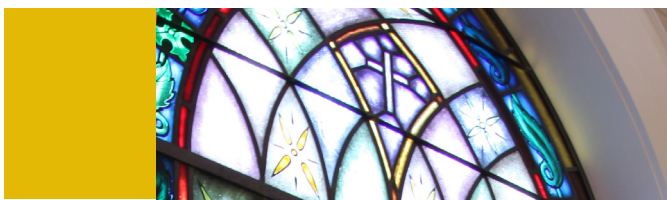

CHURCH INTERIORS, INC. 24-27



INTEGRITY FURNITURE 28-29

AFFILIATIONS



The CO+OP connects churches, schools and nonprofit organizations with reputable vendors and resources to save time and money on products, services and education.



The Church Network (TCN) is an inter-denominational professional association of churches and individuals which exists to connect, develop, and strengthen church leaders in administration.



Lifeway Christian Resources exists to honor God and serve churches by designing trustworthy experiences that fuel ministry.



ComforTek Seating has been manufacturing church chairs since 2000. They started primarily in the worship seating marketplace, manufacturing a new design of sanctuary seating that incorporated a pew like ganging style. Over the years they have honed their church chairs into one of the market leading options. With industry leading innovations such as cold cured foam and their comfort style back, they've developed a chair that is attractive, comfortable and affordable. Integrity Furniture has represented ComforTek to churches since 2005 and we appreciate them for their quality product and innovation.

Summit Series

SS7701-20" HZ



Shown in AW 19 Charcoal / Silvervein Frame

- 1" - 18 ga Steel Frame - Legs
- 3/4" - 18 ga Steel Frame - Back
- 5 Steel Cross Members
- 3" Dual Density Foam Seat
- Radius Cutaway Comfort Back
- Fabric Card Pocket Available
- Plywood Seat (5/8") / Back (1/2")
- Lumbar Support
- Ganging - Standard
- Stafast T-nuts Throughout (10X)
- Available in 18.5", 20", 22" Widths
- **Available in an Armed Model**
- **Limited Lifetime Warranty on Frame**
- **10 Year Warranty on Foam / Fabric**

Stacking Colors



AW 05 - Dark Blue
Silvervein Frame



AW 16 - Maroon
Silvervein Frame



AW 19 - Charcoal
Silvervein Frame



AW 11 - Fossil
Textured Black Frame



AW 21 - Black
Silvervein Frame



AW 29 - Espresso
Textured Black Frame

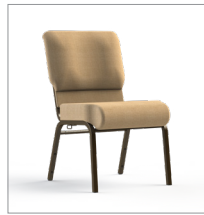

AW 101 - Mixed Tan
Antique Brown Frame

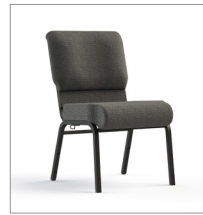

AW 101 - Black Marble
Textured Black Frame

Specifications

CAL 117E Approved

ANSI / BIFMA Approved

Stacking: 6-8 High

Dimensions: 20" W x 24" D x 34½"H

Weight: 20 Lbs.

Weight Capacity: 400 Lbs.

C.O.M.: 1.1*Yards

*No Repeats on C.O.M.

Call Integrity for information on additional fabric options that may require a longer lead time

See Chair Options on Page 5

Summit Series

SS7701-X

- 3" Cold Cured Foam Seat
- Cold Cured Foam Back
- Radius Comfort Back
- Cutaway Back
- 1" Steel Frame - Legs
- 3/4" Steel Frame - Back
- 5 Steel Cross Members
- Fabric Card Pocket Available
- Plywood Seat (5/8") / Back (1/2")
- Lumbar Support
- Ganging - Standard
- Stafast T-nuts Throughout (10X)
- Available in 20" Width
- **Limited Lifetime Warranty on Frame**
- **10 Year Warranty on Fabric**
- **15 Year Warranty on Cold Cured Foam**



Shown in Winslow Moonbeam /
Textured Black Frame

Stacking Colors



Winslow - Mineral
Textured Black Frame



Winslow - Moonbeam
Textured Black Frame

Call Integrity for
information on
additional fabric
options that may
require a longer
lead time



Winslow - Lithium
Textured Black Frame



Winslow - Onyx
Textured Black Frame

See Chair Options
on Page 5

Specifications

CAL 117E Approved
ANSI / BIFMA Approved

Stacking: 6-8 High

Dimensions: 20" W x 24" D x 34½"H

Weight: 20 Lbs.

Weight Capacity: 400 Lbs.

C.O.M.: 1.1 Yards

*No Repeats on C.O.M.

Comfortek Options



Plastic Card Pocket / Pencil Holder / Communion Cup Holder



Plastic Card Pocket / Pencil Holder



Coffee Cup Holder B



Communion Cup Holder



CM - 3A Dolly



SW-30 Dolly



SW-40 Dolly



SS7741 with Arms

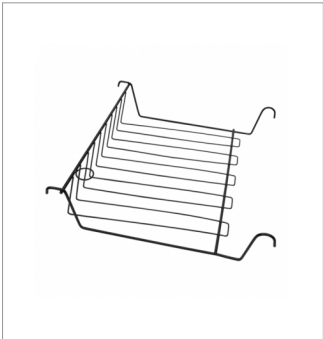

Hanging Bookrack

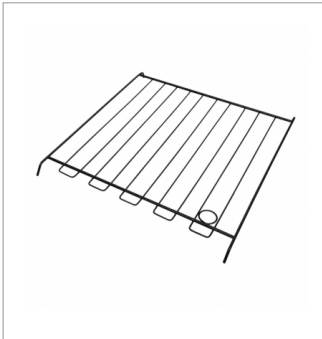

Stackable Bookrack



Retractable Kneelers



SS7721 Curved Enclosed Back



Summit Series

SS661

Multi-Purpose Stack Chair

- 1" Steel Frame - Legs
- 3/4" Steel Framework - Back Support
- Multiple Steel Cross Members
- 3" High - Density Cushion Seat
- Rolled Front
- Radius Back & Lumbar Support
- Ganging Connection - Standard
- 100% Woven Polyolefin Upholstery
- Stafast "T-nuts" & Bolt Assembly
- **Limited Lifetime Warranty on Frame**
- **10 Year Warranty on Foam / Fabric**



AW 29 - Espresso

Stacking Colors



AW 19 - Charcoal
Silvervein Frame

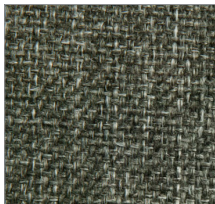

Call Integrity for information on additional fabric options that may require a longer lead time



AW 29 - Espresso
Textured Black Frame



Specifications

CAL 117E Approved
ANSI / BIFMA Approved

Stacking: 8-10 High

Seat Width: 16.5"

Dimensions: 18½" W x 24" D x 33½" H

Weight: 17 Lbs.

Weight Capacity: 400 Lbs.

C.O.M.: 1.1 Yards

*No Repeats on C.O.M.

For more information, call 1-888-600-8639.

www.integrityfurniture.com

Summit Series

791G

High Density Stacker w/ Ganging

- 7/16" Diameter Solid Steel Frame
- Molded Polypropylene Seat / Back
- Chrome Frame Finish
- Contoured Design for Strength and Comfort
- Non-marring Floor Glides - Standard
- Handhold for Easy Handling
- Stacks 30-35 High on SW30 Dolly
- Steel Welded Ganging Connector
- **10 Year Warranty on Frame**
- **5 Year Warranty on Polypropylene**



Bright Blue

Stacking Colors



Slate



Yellow



Oyster



Indigo



Black



Mercury



SW30 Dolly

Specifications

Stacking: 30 High (Height of 75")

Stacking: 35 High (Height of 84")

Dimensions: 19½" W x 20" D x 30½"H

Weight: 14 Lbs.

Weight Capacity: 300 Lbs.



 **BERTOLINI**
SANCTUARY® SEATING



For more than 60 years, Bertolini has produced high quality chairs and delivered seating options that bring elegance, comfort, and durability to worship centers throughout the United States. Their Ergo-V plastic back creates a lightweight chair that helps facility teams that set up and take down regularly. Their commitment to excellence shows in the quality of the materials they use, their innovative assembly techniques, and the rigorous testing and inspection process their chairs undergo. Bertolini manufactures their seating in Lawrenceburg, Tennessee.

Bertolini Essentials



- 16 ga Steel Frame – Legs
- 16 ga Steel Frame – Back
- Integrated Torsion Bar
- 3.5" Dual Density Foam
- Closed-Loop Frame Back
- Wood Seat and Back
- Passive Lumbar Support
- Ganging – Standard
- T-nut metal-to-metal Fasteners
- 20" Width Available
- Available in Armed Model
- **20 year Warranty on Frame**
- **10 year Warranty on Foam**
- **5 year Warranty on Fabric**

Standard Fabric Options



Shire Stonewall Grade A Shire Black Marble Grade A Sherpa Grey Heather Grade A Winslow Belize Grade D Winslow Mineral Grade D Fandango Ash Grade D

Call Integrity for swatch card with hundreds of additional fabrics

Standard Frame Options

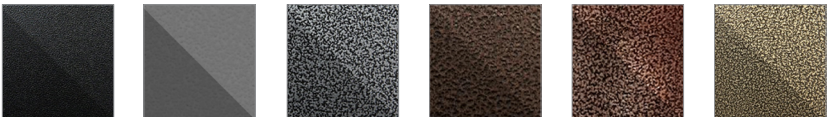

Enviro Black Gray Hammer Silver Vein Bronze Vein Copper Vein Gold Vein

Specifications

Meets or Exceeds California Bulletin 117-2013
Meets or Exceeds ANSI/BIFMA X 5.1-2002

Stacking: Armless(8) / Armed(6)
Dimensions: 20.25"W x 25"D x 35"H
Weight: 17.9 Lbs.
Weight Capacity: 1000 Lbs.
C.O.M: .80 - 1.1 yards

See Chair Options on Page 13

Bertolini Millennia



- 16 ga Steel Frame – Legs
- 16 ga Steel Frame – Back
- Integrated Torsion Bar
- 3.5" Dual Density Foam
- Ergo-V Ergonomic Back
- Wood Seat / Plastic Back
- Ergonomic Back Support
- Ganging – Standard
- T-nut metal-to-metal Fasteners
- 20" Width Available
- Available in Armed Model
- **20 year Warranty on Frame**
- **20 year Warranty on Foam**
- **5 year Warranty on Fabric**

Stacking Colors

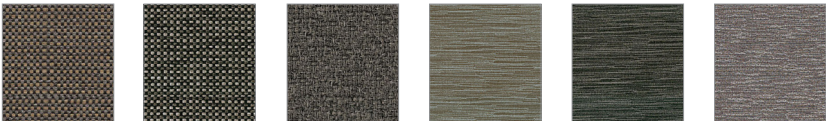

Shire Stonewall Grade A Shire Black Marble Grade A Sherpa Grey Heather Grade A Winslow Belize Grade D Winslow Mineral Grade D Fandango Ash Grade D

Call Integrity for swatch card with hundreds of additional fabrics

Standard Frame Options

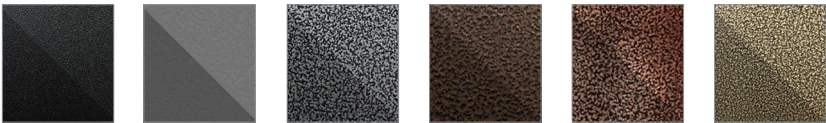

Enviro Black Gray Hammer Silver Vein Bronze Vein Copper Vein Gold Vein

Specifications

Meets or Exceeds California Bulletin 117-2013
Meets or Exceeds ANSI/BIFMA X 5.1-2002

Stacking: Armless(8) / Armed(6)
Dimensions: 20.25"W x 26.3"D x 35"H
Weight: 16.3 Lbs.
Weight Capacity: 1000 Lbs.
C.O.M: .80 - 1.1 yards

See Chair Options on Page 13

For more information, call 1-888-600-8639.
www.integrityfurniture.com

Bertolini Impressions



- 16 ga Steel Frame – Legs
- 16 ga Steel Frame – Back
- Integrated Torsion Bar
- Flex-Fit Blow Molded Seat
- 3.5" Dual Density Foam
- Ergo-V Ergonomic Back
- Blow Molded Plastic Seat
- Ergonomic Back Support
- Ganging – Standard
- Fit-Tight with BosScrew Fasteners
- 20" and 22" Widths Available
- Available in Armed Model
- **25 year Warranty on Frame**
- **25 year Warranty on Foam**
- **5 year Warranty on Fabric**

Standard Fabric Options



Shire Stonewall Grade A Shire Black Marble Grade A Sherpa Grey Heather Grade A Winslow Belize Grade D Winslow Mineral Grade D Fandango Ash Grade D

Call Integrity for swatch card with hundreds of additional fabrics

Standard Frame Options

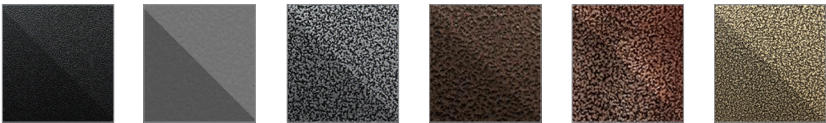

Enviro Black Gray Hammer Silver Vein Bronze Vein Copper Vein Gold Vein

Specifications

Meets or Exceeds California Bulletin 117-2013
Meets or Exceeds ANSI/BIFMA X 5.1-2002

Stacking: Armless(8) / Armed(6)

Dimensions: 20.25"W x 25.75"D x 35"H

Weight: 176 Lbs.

Weight Capacity: 1000 Lbs.

C.O.M: .80 - 1.1 yards

See Chair Options on Page 13

Bertolini Options



Arm Chair Bookrack



Armchair with Communion Cup Holder



Bookrack with Communion Cup Holder



Coffee Cup Holder



Communion Cup Holder



Card/Pencil/Communion Cup Holder



Retractable Interlocks



Armed Chair



Attached Kneeler



Kneeler under Chair



Dolly

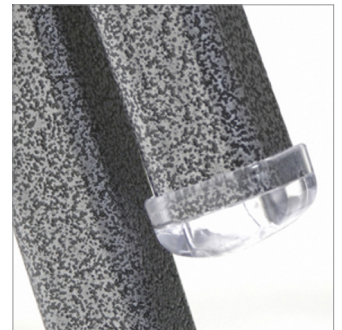

Clear Glides

For more information, call 1-888-600-8639.
www.integrityfurniture.com



SEIRES[®]
S E A T I N G

SERIES Seating is the industry leader in product innovation and design solutions in the seating industry. They have proven excellence in the Performing Arts, Worship, Education, Stadium, and Cinema Markets. Their vast selection of public seating is customizable to meet your needs and best fit your space. Their front-line approach to product design ensures the highest-quality, most cost-effective solutions in the market. Their products are sure to exceed your expectations. SERIES Seating utilizes your space most efficiently, while optimizing your comfort.

At SERIES Seating, they value their long-term customer relationships. Their expertise in delivering first-class solutions has made them an industry leader for over 30 years. They are continually reinventing and setting new standards for the seating market across the globe. They are committed to providing you with excellent service and delivering the finest-quality solutions for all of your future needs.

Call Integrity Furniture today to request more information or set an appointment to see a sample and learn more about Series Seating.

Series Seating

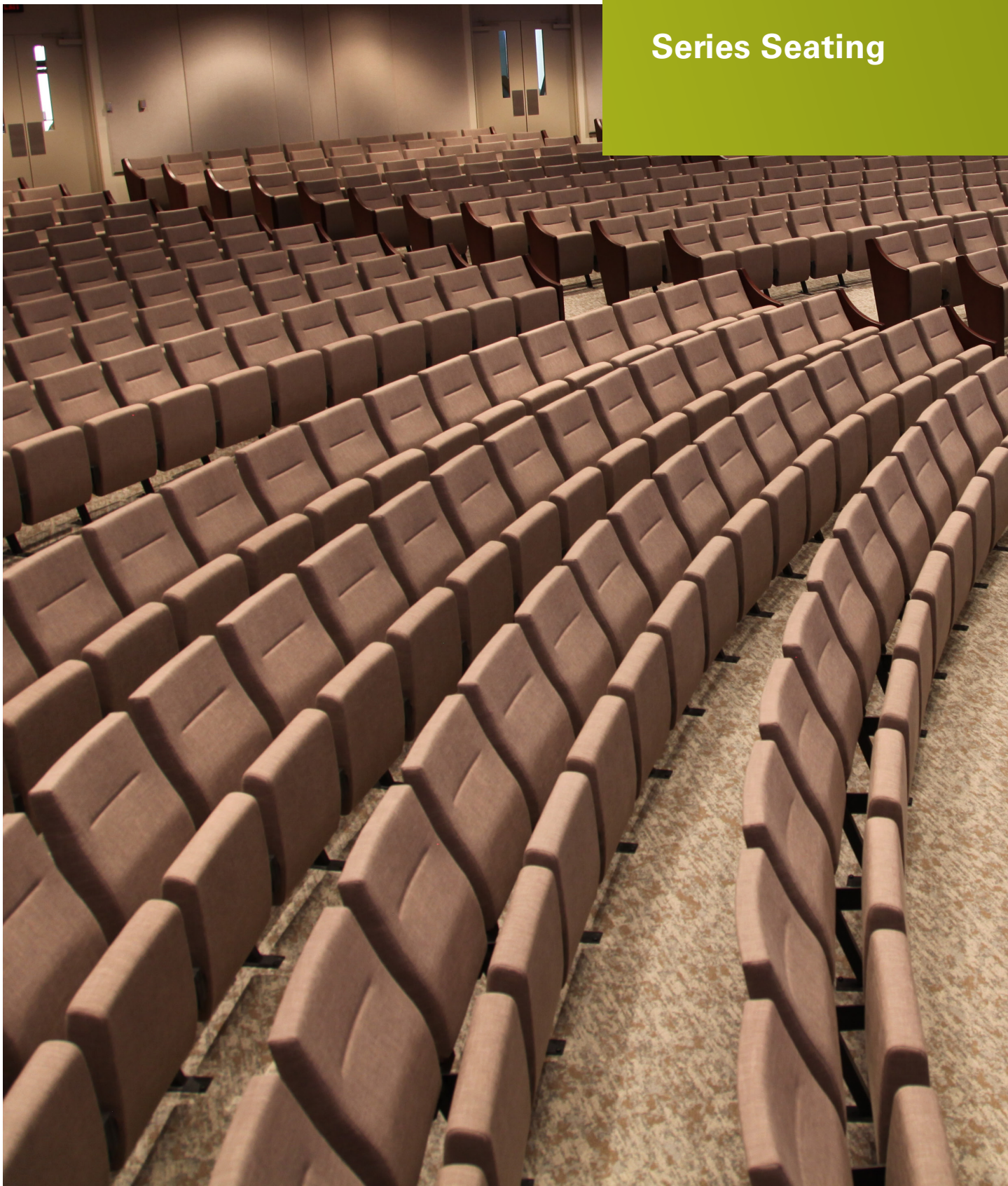

Series Seating

Stewardship Sensitive Seating



Twelve Benefits Over Conventional Pews

There are twelve distinct benefits to the SERIES Vera chair over conventional pews.

1. Provides between 20% to 30% gain in seating capacity over the use of pews.
2. Provides greater traffic flow.
3. Presents a lower overall cost per person.
4. Allows a radial layout configuration.
5. Provides better sightlines for each individual.
6. Provides reduced maintenance / lower cost of ownership.
7. Reduces other code requirements imposed by pews.
8. Makes it easier and less expensive to reupholster.
9. Is more conducive to growth and expansion.
10. Is more conducive to special events.
11. Provides more comfort in both a seated and standing position.
12. Directly enables churches to serve the community in new and creative ways.

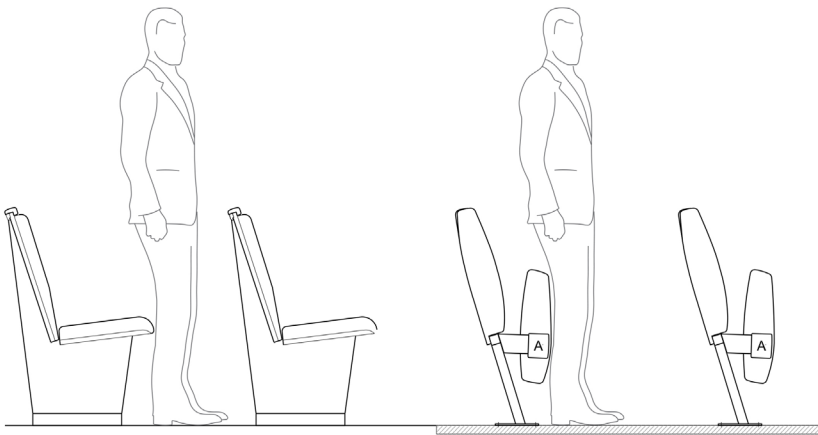

As you can see in the image above, using the same spacing for pews and fixed seating, the ingress and egress is much greater and easier to maneuver with fixed seating.

BEFORE - 1488 seats

Building codes limit the length of a pew to a maximum of 21'-6" which increases the number of required aisles. The pew layout below calls for a minimum of 9 aisles, creating a loss of seats for a total capacity of only 1488.

Series Seating

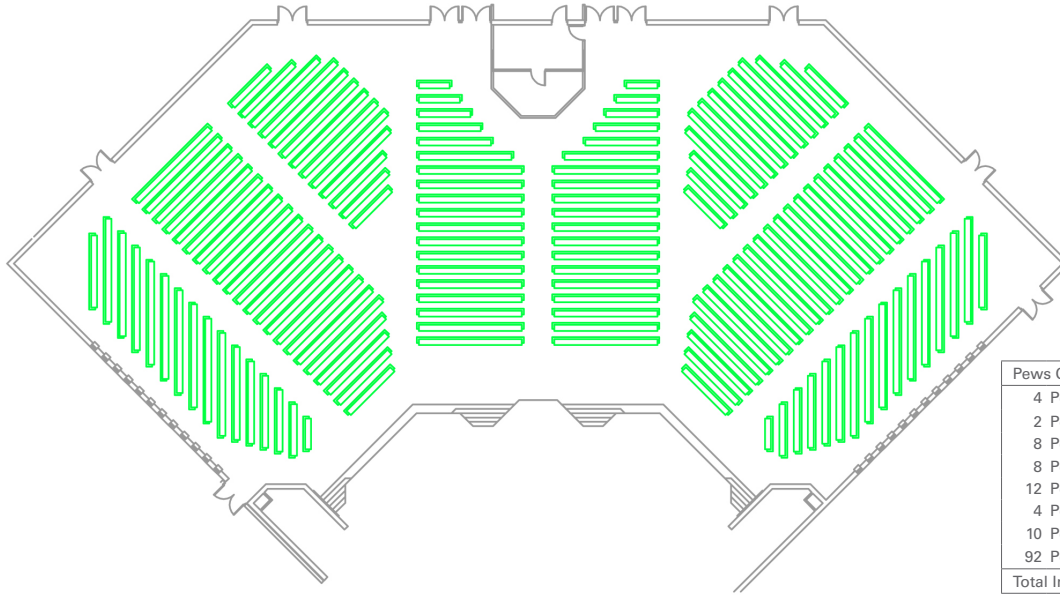

Pews Quantities and Lengths		
4 Pews	7'4"	= 352"
2 Pews	9'6"	= 228"
8 Pews	11'8"	= 1120"
8 Pews	13'10"	= 1328"
12 Pews	16'0"	= 2304"
4 Pews	18'2"	= 872"
10 Pews	20'4"	= 2440"
92 Pews	22'6"	= 24840"
Total Inches		33484"
Capacity 1488 @ 22.5" per person		

AFTER - 1880 seats

Fire codes recognize the added egress provided by the Series VERA chair, permitting more than three times the row length of a pew. This reduces the number of required aisles to only 5 for a total of 1880 seats and a 26% gain in seat capacity, just from the difference in aisles alone.

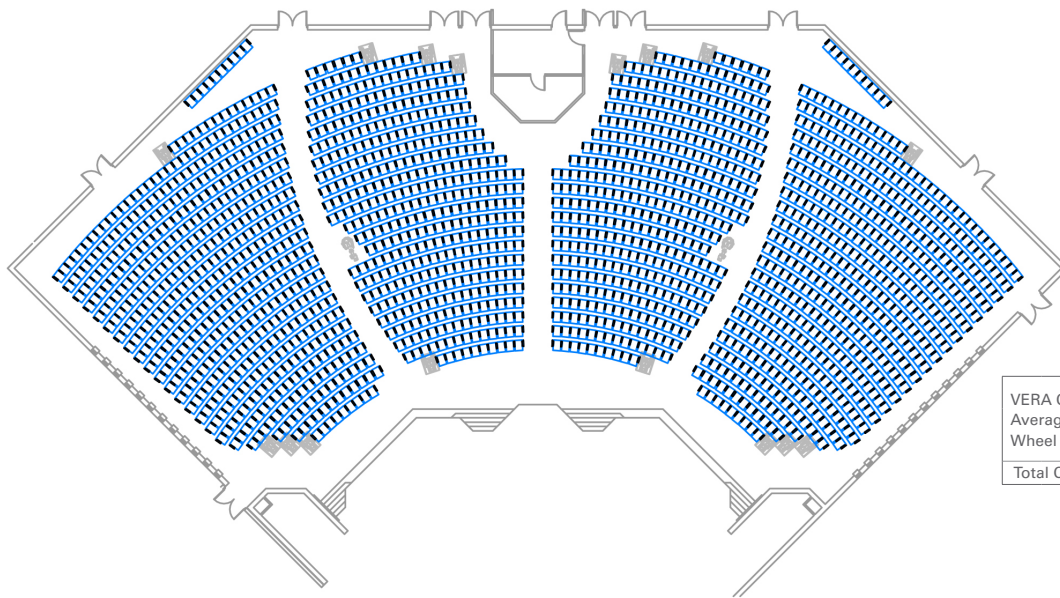

VERA Chair	
Average width	22.5" = 1864
Wheel chair spaces	= 16
Total Capacity	1880

For more information, call 1-888-600-8639.

www.integrityfurniture.com

Series Seating



Series Seating

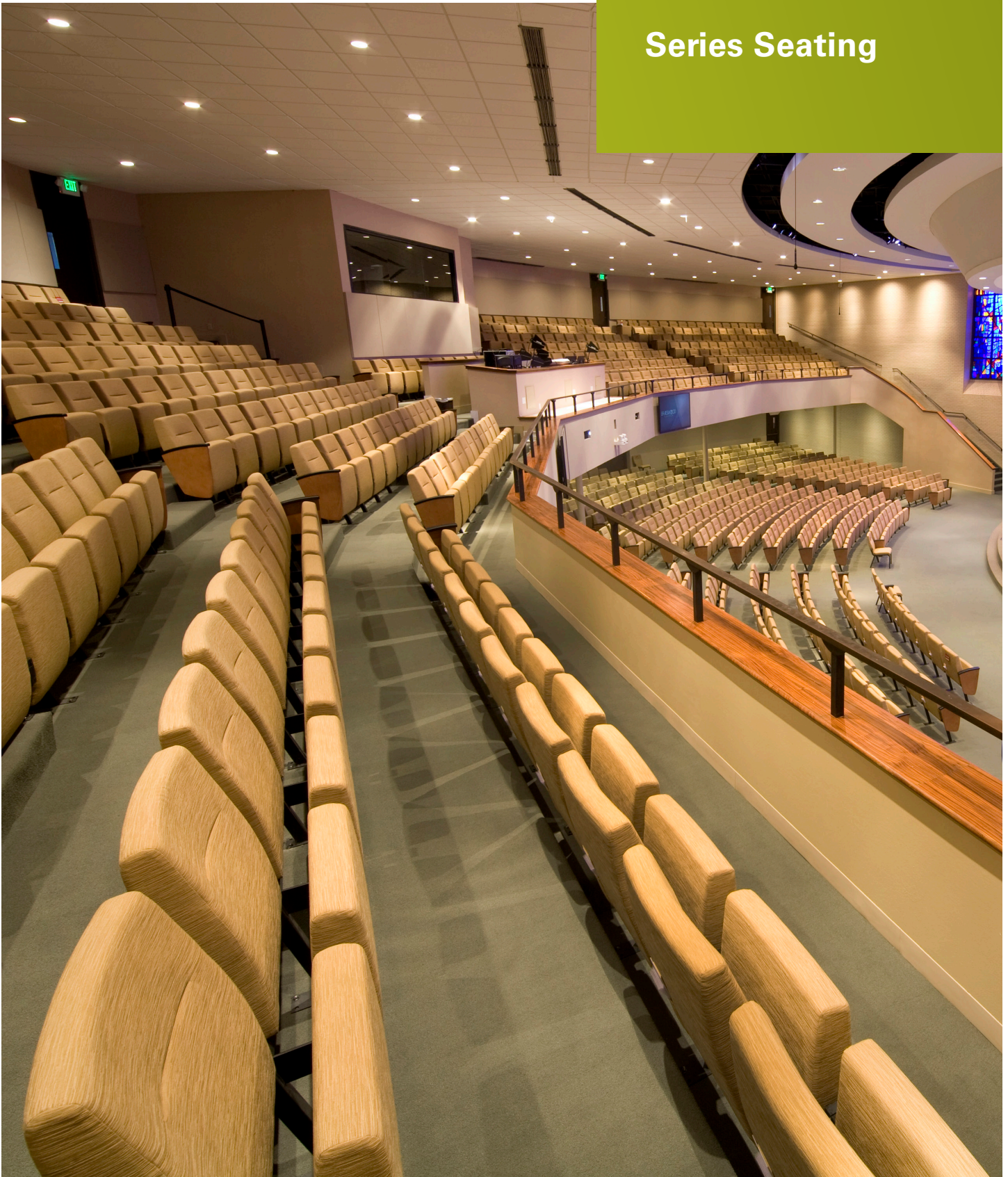

For more information, call 1-888-600-8639.
www.integrityfurniture.com



PEWS

A pew purchase is often referred to as a “50 Year decision,” so you better make the right decision or you’ll live with the consequences a long time. Through our strategic partners, Integrity Furniture has several pew manufacturers that we can recommend to your church based on your budget, style, and need for customization. Each of our manufacturers have been producing pews and chancel furniture for over 60 years. Their craftsmen provide products made from the finest of materials. Contact Integrity Furniture today to set up a free consultation.

- Solid oak or hardwood ends, supports, book racks, card & pencil holders and seat frames
- 30 Year Warranty on all wood components and fabric.
- Custom Ends Available

Pews



TR15



TR12



TR10



TR11



TR6G



M6



TR4



TR6



M15C

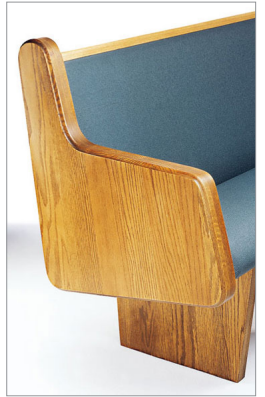

M11C



C110



C8RRP



C6RP



Custom End

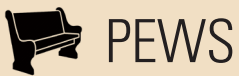

For more information, call 1-888-600-8639.
www.integrityfurniture.com

- On-Site work will not interrupt church services.
- High density foam custom fit to each pew.
- Available 'Super Fabrics' resist liquids, soiling, damaging UV rays and wrinkling.

Pew Upholstery

On-Site

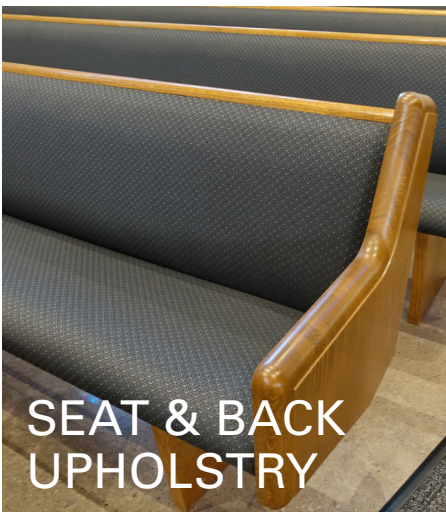

**SEAT & BACK
UPHOLSTERY**

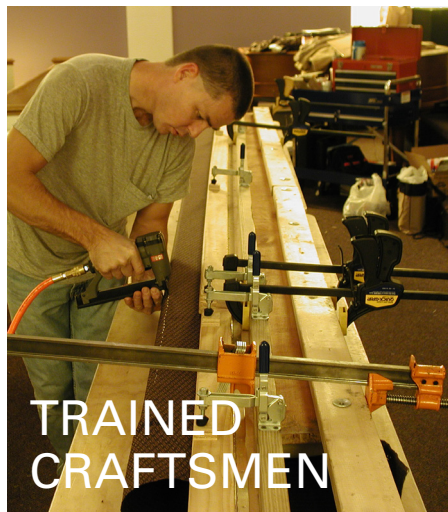

**TRAINED
CRAFTSMEN**



**HIGH QUALITY
FABRIC & FOAM**

- Refinishing the original furniture preserves the historical integrity of the sanctuary.
- Pew refinishing cost less than new pews of the same quality.
- Completely restored pews are disassembled and transported to refinishing facility.

Pew Refinishing

On-site or Off site



For more information, call 1-888-600-8639.
www.integrityfurniture.com

Church Interiors, Inc.



Integrity Furniture is pleased to partner with Church Interiors, Inc. to help churches remodel their facilities. Church Interiors, Inc. has renovated small chapels that seat less than 100 people to large sanctuaries & cathedrals that seat over 5,000, including many churches on the Historical Registry. Design, renovate, and furnish is how they simplify the process for their clients and they perform services to hundreds of churches every year, saving every church client time and money. Church Interiors, Inc. has a Nationwide Dealer Network of project consultants and installers who are eager to make improvements to your church.

Their goal is to make your worship spaces beautiful at the lowest possible cost with little or no disruption to your church services. In the early stages, they work with your congregation committee to create a design that works best for your needs. There is no charge for their initial consultations.

Church Interiors, Inc. began working with churches on renovations and building projects in 1981 and they have completed thousands of renovations. Integrity Furniture is ready to help you make the connection with Church Interiors, Inc. and began your remodeling process. Give us a call at 1-888-600-8639 to get started.

SERVICES

PROJECT CONSULTING

Our Project Consultants can assist with improvements to your church facilities through experience and training.

DESIGN & CONSTRUCTION

As a church design-build general contractor, we can assist with planning as a turnkey entity. Our experience gives us the tools to help you plan for the future.

INTERIOR DESIGN & ARCHITECTURE

Our Interior Designers and Liturgical Designers work with churches exclusively and are sensitive to all styles of worship.

RENDERINGS

Our 4K Resolution Renderings create excitement with a preview of your future project.



PRODUCTS

LIGHTING, AUDIO & VIDEO

- LED Lighting, New, Retrofit, and Custom
- Performance Lighting
- Audio/Video: Design, Installation and Training

FLOORING

- Carpet: Broadloom & Modular/Carpet Tiles
- Hard Surfaces: New Hardwood Flooring, Hardwood Refinishing, Luxury Vinyl Tile and Porcelain Tile

SPECIALTY SERVICES

- Stained Glass
- Chancel Furniture
- Pew Cushions
- Welcome Center & Fellowship
- Youth Area Design
- Way Finding & Signs

PAINTING & PLASTER REPAIR

Our experienced paint crew repair, restore, and replicate all existing wall and ceiling finishes.



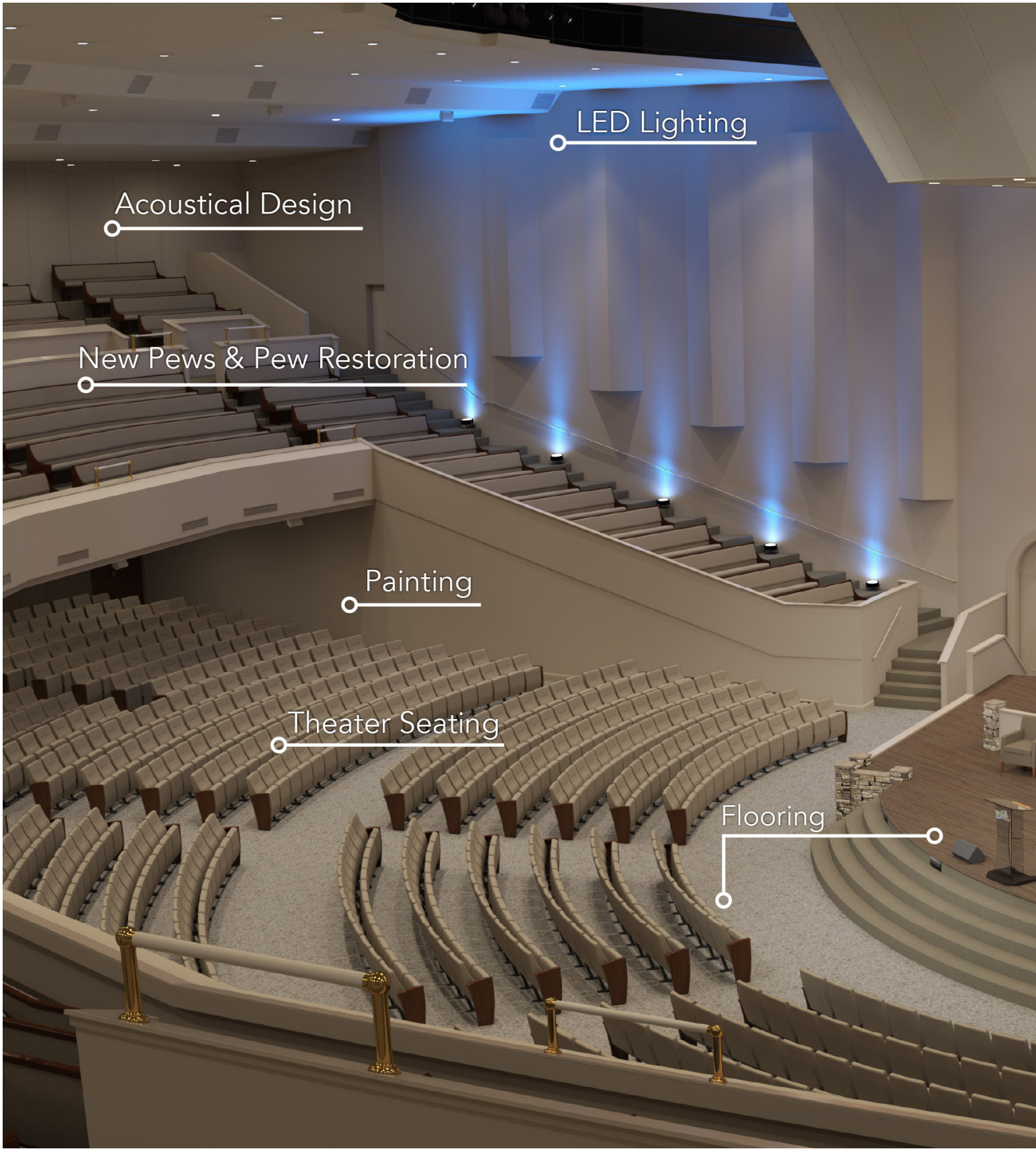

LED Lighting

Acoustical Design

New Pews & Pew Restoration

Painting

Theater Seating

Flooring



Church Interiors, Inc.

Services

Audio / Video/ Theatrical Lighting



Accent Walls



Flexible Seating

Stage Design & Construction

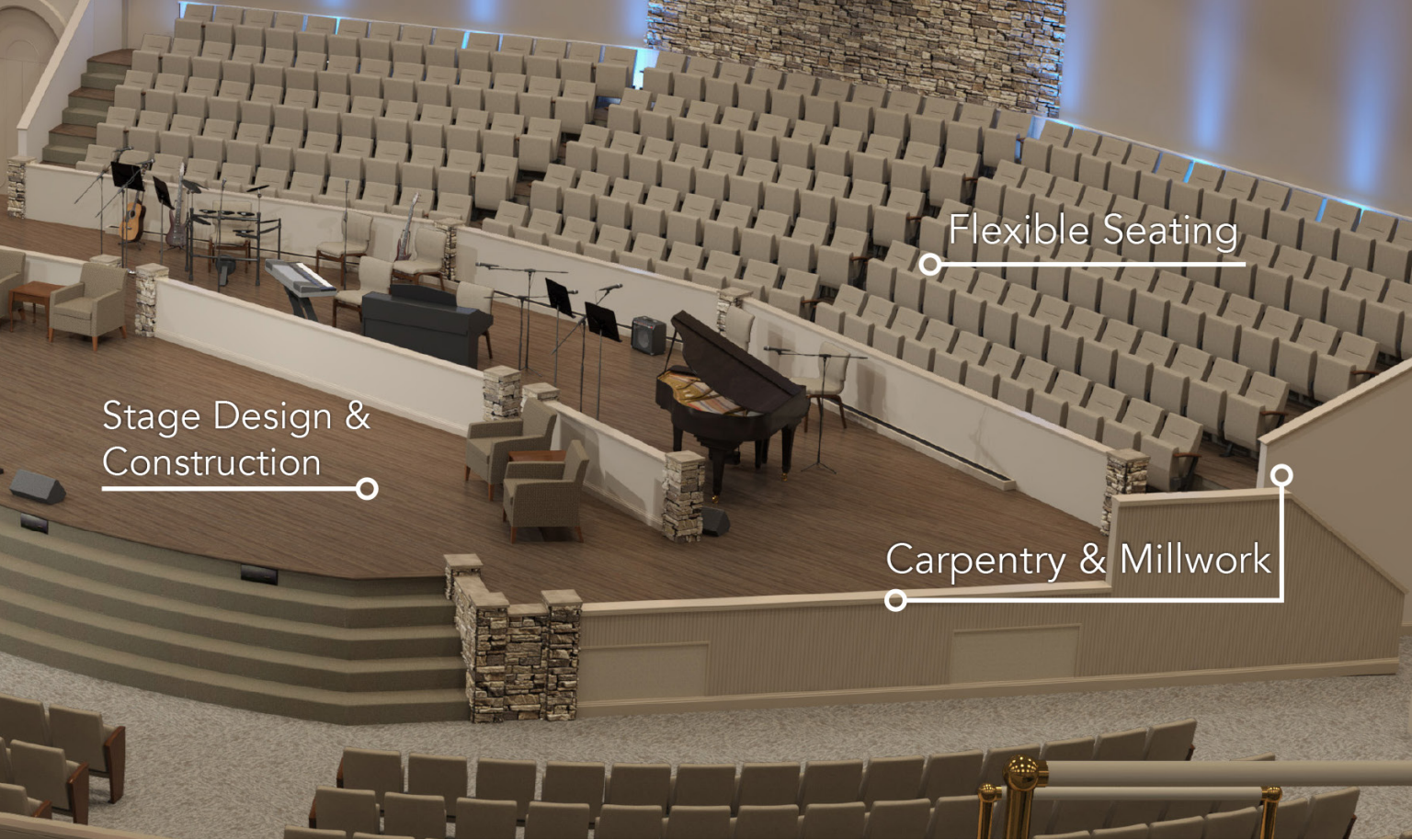

Carpentry & Millwork

For more information, call 1-888-600-8639.
www.integrityfurniture.com



Office & Lounge Furniture Solutions

- Office Desk and Chairs
- Cubicles
- Conference Tables
- Lounge/Lobby Furniture
- Storage



Table Solutions

- Folding Tables
- Seminar/Training Tables
- Flip Top Tables
- Café Tables
- Mobile Cafeteria Tables



School Furniture Solutions

- Student Desks/Chairs
- Teacher Desks/Chairs
- Science Desks/Stools
- Library Furniture
- Lockers



Early Childhood Solutions

- Activity Tables/Chairs
- Wood Play/Soft Play
- Area Rugs
- Nursery Furniture
- Outdoor Playgrounds

Integrity Furniture

Furniture Solutions

Stage & Riser Solutions

Portable Stages
Mobile Stages
Choir Risers
Skirting
Stage Storage Systems

Audio/Visual Solutions

Podiums
Lecterns
TV Stands
Mobile Carts
Projection Screens

Communication Board Solutions

Marker Boards
Bulletin Boards
Chalk Boards
Combination Boards
Free Standing Flip Boards

Outdoor Furniture Solutions

Benches
Tables
Chairs
Trash Cans
Planters

For more information, call 1-888-600-8639.

www.integrityfurniture.com

OUR MISSION STATEMENT:

“To HONOR God through our relationships with our customers and suppliers.”

“He has told you, O man, what is good; and what does the Lord require of you but to do justice, and to love kindness, and to walk humbly with your God?”

Micah 6:8 ESV

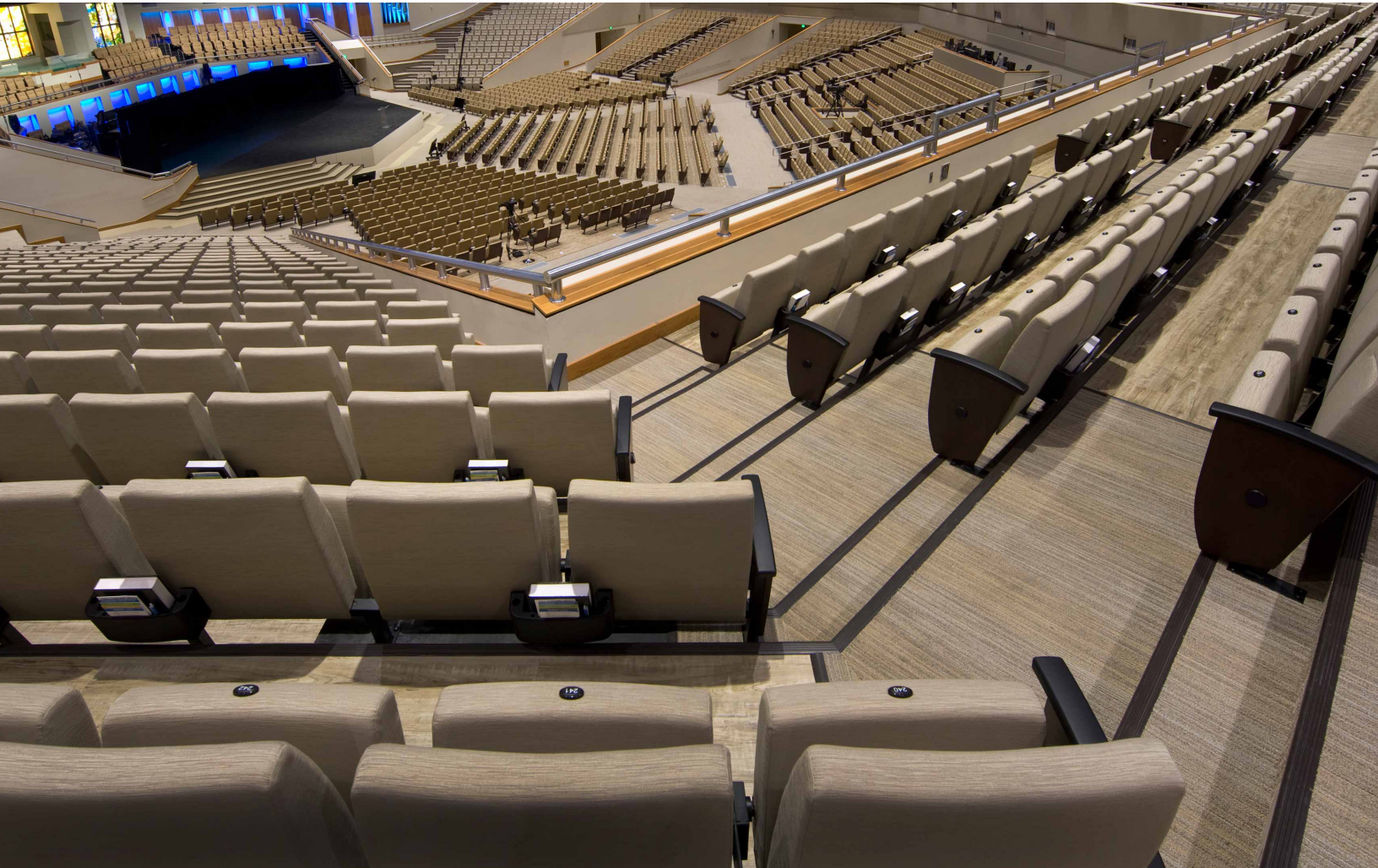

Contact Us:

National Office | PO Box 6523, Longview, TX 75608

Regional Office | PO Box 671273, Dallas, TX 75367

sales@integrityfurniture.com

www.integrityfurniture.com

www.integrityfurniture.com

 **INTEGRITY**
FURNITURE.com

1-888-600-8639